

PLD - PRODIGY LINEAR MOTORIZED VAV DIFFUSER

ELECTRONIC FIELD CONNECTIONS OPTIONAL TRANSFORMER OR BACnet

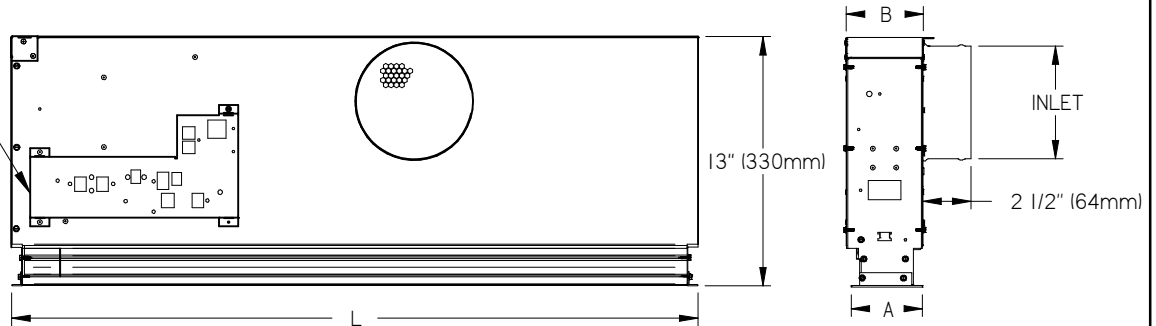

DIFFUSER TYPE:

- MASTER - INCLUDES ONBOARD CONTROLS, MAY ALSO CONTROL AND DISTRIBUTE POWER UP TO 5 DRONES FROM EACH MASTER
- DRONE - REPLICATES THE DAMPER POSITION OF THE MASTER. INCLUDES NETC35 PLENUM RATED 35 FT. (10.7m) CABLE WITH RJ-12 CONNECTORS (DRONE BOARD NOT SHOWN)
- RAD - MATCHING RETURN, DUCTED WITH PLENUM. DIMENSIONS ARE EQUIVALENT TO STANDARD PLD.
- RAP - MATCHING RETURN, FOR OPEN PLENUM. DIMENSIONS ARE REFERENCED BELOW.

POWER REQUIREMENTS:

24 VAC INPUT POWER, 3.0 VA PER UNIT (MASTER OR DRONE)

- 60Hz
- 50Hz

SEE MODEL PPM FOR STAND-ALONE POWER MODULE (UP TO 15 UNITS)

OPTIONAL ON-BOARD TRANSFORMERS (MASTER ONLY):

- TR115 - 115/24, 20 VA TRANSFORMER
- TR240 - 240/24, 20 VA TRANSFORMER
- TR277 - 277/24, 20 VA TRANSFORMER

NETWORK OPTION (MASTER ONLY):

- BACnet SYSTEM INTERFACE (MS/TP) INCLUDES NETC35 PLENUM RATED 35 FT. (10.7m) NETWORK CONNECTION CABLE (RJ45)

MATERIAL:

DIFFUSER FACE - EXTRUDED ALUMINUM
PLENUM - COATED STEEL CONSTRUCTION

OPTIONS:

- FF - INSULATED PLENUM (FIBER FREE FOAM)

FINISH:

- B12 - WHITE POWDER COAT (OPTIONAL FINISHES AVAILABLE)

OPTIONAL AUXILIARY HEAT CONTROL OUTPUT: (12VA MAX. MASTER UNIT ONLY)

- PDM - PULSE DELAY MODULATION
- PWM - PULSE WIDTH MODULATION
- BIN - BINARY ON/OFF

NOTES:

- FACTORY TOLERANCE ±1/16" (2mm)
- STANDARD PLENUM HEIGHT H = 13" (330mm)
- END ANGLES FOR CONTINUOUS UNITS ARE SHIPPED LOOSE FOR FIELD INSTALLATION AT ENDS OF RUN
- CONTINUOUS DIFFUSERS - FIELD TRIMMING MAY ONLY BE DONE ON MODEL PLD-RAP RETURN SECTIONS

ALL METRIC DIMENSIONS () ARE SOFT CONVERTED. IMPERIAL DIMENSIONS ARE CONVERTED TO METRIC AND ROUNDED TO THE NEAREST MILLIMETER.

	PATTERN	A	B
<input type="checkbox"/>	1 Slot, 1 Way	2 9/16" 65mm	4" 102mm
<input type="checkbox"/>	2 Slot, 1 Way	3 3/4" 95mm	4" 102mm
<input type="checkbox"/>	2 Slot, 2 Way	4" 102mm	4" 102mm
<input type="checkbox"/>	4 Slot, 1 Way	6" 152mm	6 5/16" 160mm
<input type="checkbox"/>	4 Slot, 2 Way	6 3/8" 162mm	6 5/16" 160mm

	NOM. LENGTH	L	
		Single Unit	Continuous
<input type="checkbox"/>	24"	23 3/4"	24 5/8"
<input type="checkbox"/>	36"	35 3/4"	36 5/8"
<input type="checkbox"/>	48"	47 3/4"	48 5/8"
<input type="checkbox"/>	60"	59 3/4"	60 5/8"
<input type="checkbox"/>	600mm	594mm	616mm
<input type="checkbox"/>	900mm	894mm	916mm
<input type="checkbox"/>	1200mm	1194mm	1216mm
<input type="checkbox"/>	1500mm	1494mm	1516mm

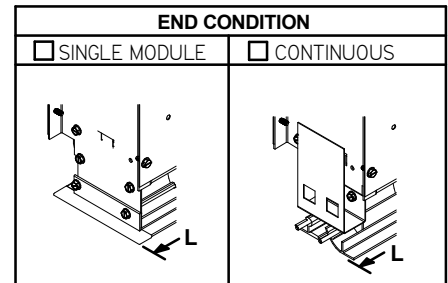

PROJECT:		PRICE
ENGINEER:		
CUSTOMER:		PLD
SUBMITTAL DATE:		PRODIGY LINEAR DIFFUSER SELF MODULATING MOTORIZED VAV DIFFUSER
SPEC. SYMBOL:		271991
		SEPTEMBER 2020

PLD - PRODIGY LINEAR MOTORIZED VAV DIFFUSER

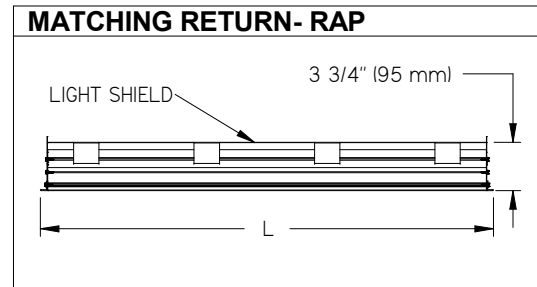
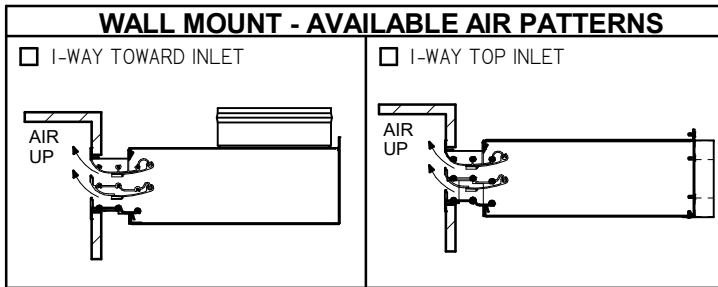
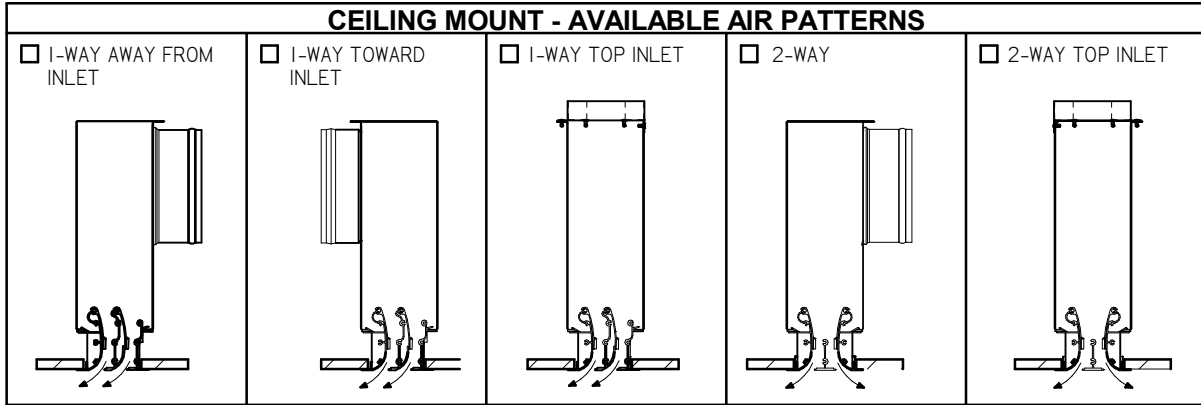

NOMINAL LENGTH:		Standard Plenum - Side Inlet	Top Inlet
24" / 600mm	1 & 2 Slot	6" (152mm)	4" x 8" (102mm x 203mm)
	4 Slot	8" (203mm)	6" x 10" (152mm x 254mm)
36" / 900mm	1 & 2 Slot	6" (152mm)	4" x 8" (102mm x 203mm)
	4 Slot	8" (203mm)	6" x 10" (152mm x 254mm)
48" / 1200mm	1 & 2 Slot	8" (203mm)	4" x 16" (102mm x 406mm)
	4 Slot	10" (254mm)	6" x 18" (152mm x 457mm)
60" / 1500mm	1 & 2 Slot	8" (203mm)	4" x 16" (102mm x 406mm)
	4 Slot	9 7/8" x 12 3/4" (12" equivalent)	6" x 18" (152mm x 457mm)

ALL METRIC DIMENSIONS () ARE SOFT CONVERTED. IMPERIAL DIMENSIONS ARE CONVERTED TO METRIC AND ROUNDED TO THE NEAREST MILLIMETER.

PROJECT:		
ENGINEER:		
CUSTOMER:		271991
SUBMITTAL DATE:	SPEC. SYMBOL:	SEPTEMBER 2020
		PLD PRODIGY LINEAR DIFFUSER SELF MODULATING MOTORIZED VAV DIFFUSER

PLD - PRODIGY LINEAR MOTORIZED VAV DIFFUSER

SETPOINT ADJUSTMENT OPTIONS (MASTER ONLY):

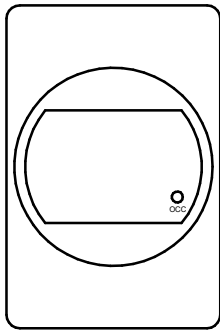

SENS - THERMOSTAT SENSOR WITH BLANK FACE

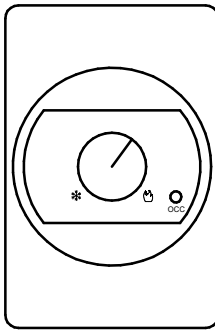

DIAL - THERMOSTAT WITH DIAL SETPOINT ADJUSTMENT

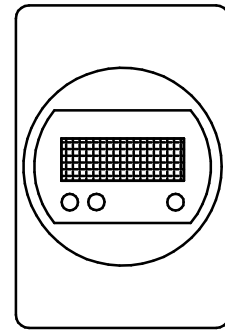

LCD THERMOSTAT (°F)
 LCD THERMOSTAT (°C)

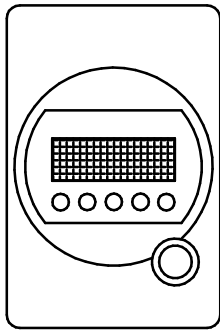

MOT - LCD THERMOSTAT WITH MOTION SENSOR (°F)
 MOT - LCD THERMOSTAT WITH MOTION SENSOR (°C)

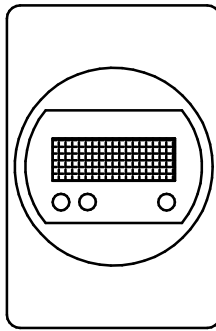

WIRELESS BASE RECEIVER

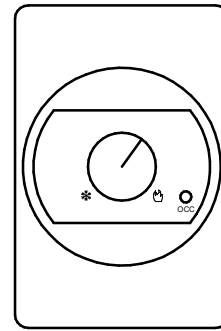

WIRELESS REMOTE DIAL THERMOSTAT

WL - WIRELESS THERMOSTAT WITH DIAL SETPOINT ADJUSTMENT

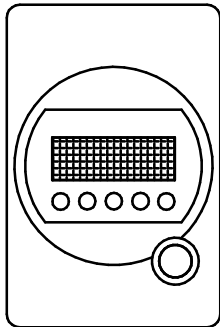

CO2H - LCD THERMOSTAT CO AND HUMIDITY SENSORS (°F)
 CO2H - LCD THERMOSTAT CO AND HUMIDITY SENSORS (°C)

NOTE:

- THERMOSTATS ARE WALL MOUNTED
- RJ-45 CONNECTION ON BACK SIDE OF THERMOSTATS FOR EASE OF INSTALLATION
- THERMOSTATS ALSO INCLUDE ONE NETC35 - 35 FT. (10.7m) PLENUM RATED CABLE INCLUDED FOR CONNECTION TO DIFFUSER

ALL METRIC DIMENSIONS () ARE SOFT CONVERTED. IMPERIAL DIMENSIONS ARE CONVERTED TO METRIC AND ROUNDED TO THE NEAREST MILLIMETER.

PROJECT:

ENGINEER:

CUSTOMER:

SUBMITTAL DATE:

SPEC. SYMBOL:



aj
271991

PLD
PRODIGY LINEAR DIFFUSER
SELF MODULATING
MOTORIZED VAV DIFFUSER

SEPTEMBER 2020

PLD - PRODIGY LINEAR MOTORIZED VAV DIFFUSER

BORDER OPTIONS

STANDARD FRAMES
15/16" T-BAR

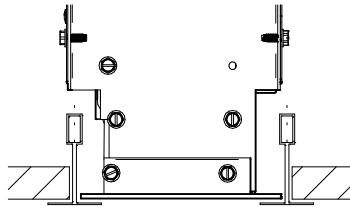

TG9 - 9/16" BOLT SLOT
OR TEGULAR

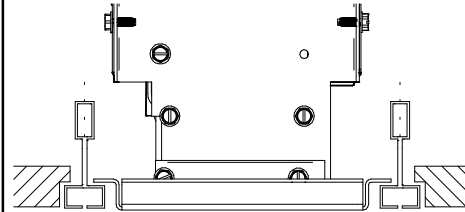

N/A on continuous units

APF - PLASTER FRAME

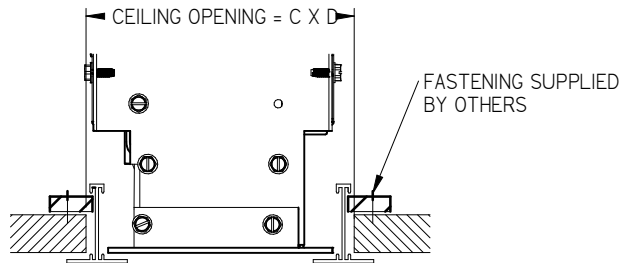

N/A on continuous units

Opening Dimensions for Optional APF Plaster Frame:

	C	Nom. Length	D
1 Slot, 1 Way	3 1/4"	24"	24 7/16"
	83mm	36"	36 7/16"
2 Slot, 1 Way	4 7/16"	48"	48 7/16"
	113mm	60"	60 7/16"
2 Slot, 2 Way	4 11/16"	600mm	611mm
	119mm	900mm	911mm
4 Slot, 1 Way	6 11/16"	1200mm	1211mm
	170mm	1500mm	1511mm
4 Slot, 2 Way	7 1/16"		
	179mm		

NOTES:
• ALUMINUM PLASTER FRAME OPTIONS AVAILABLE FOR CONTINUOUS UNITS AS A SPECIAL

ALL METRIC DIMENSIONS () ARE SOFT CONVERTED. IMPERIAL DIMENSIONS ARE CONVERTED TO METRIC AND ROUNDED TO THE NEAREST MILLIMETER.

PROJECT:		PRICE
ENGINEER:		
CUSTOMER:		a2
SUBMITTAL DATE:		271991
SPEC. SYMBOL:		SEPTMBER 2020
		PLD PRODIGY LINEAR DIFFUSER SELF MODULATING MOTORIZED VAV DIFFUSER

PLD - PRODIGY LINEAR MOTORIZED VAV DIFFUSER

CIRCUIT BOARD CONNECTIONS - DRONE UNITS:

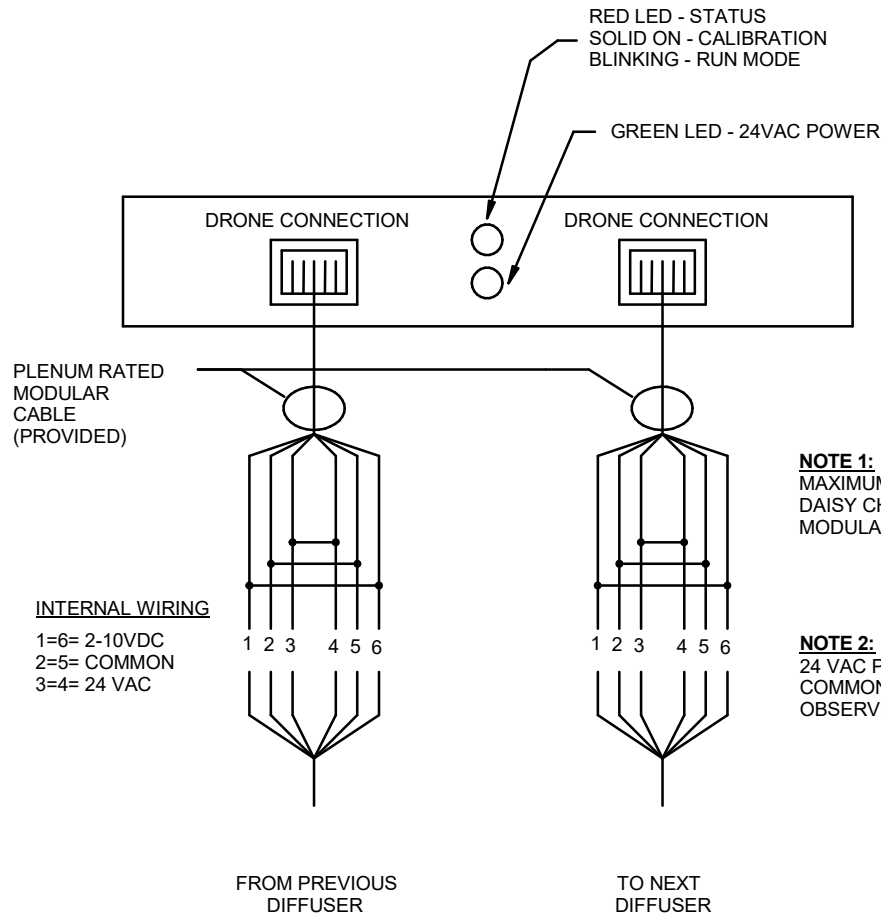

NOTE 1:
MAXIMUM OF 5 DRONES CAN BE DAISY CHAINED TOGETHER USING MODULAR RJ-12 CABLES

NOTE 2:
24 VAC POWER SIGNAL SHARE COMMON / GROUND TERMINAL. OBSERVE POLARITY BETWEEN UNITS

LINE LEGEND

- OPTIONAL FACTORY CONNECTION
- FACTORY ELECTRICAL CONNECTION
- - - - - FIELD ELECTRICAL CONNECTION

SIGNAL	DAMPER POSITION
0-2 VDC	NO SIGNAL DAMPER GOES TO 50%
2-10 VDC	PROPORTIONAL 2 VDC = MIN, 10 VDC = MAX

POWER
EACH DRONE USES 3.0VA
INPUT IMPEDANCE 200K (2-10 VDC SIGNAL)

ALL METRIC DIMENSIONS () ARE SOFT CONVERTED. IMPERIAL DIMENSIONS ARE CONVERTED TO METRIC AND ROUNDED TO THE NEAREST MILLIMETER.

PROJECT:		PRICE
ENGINEER:		
CUSTOMER:		a2
SUBMITTAL DATE:		271991
SPEC. SYMBOL:		PRODIGY LINEAR DIFFUSER SELF MODULATING MOTORIZED VAV DIFFUSER
		SEPTEMBER 2020